

911 address shall be a minimum of 3" lettering marked on meter enclosure, pole, or durable material attached to pole and should be visible from street. (See section 3.4)

Shall meet requirements of drawings D4-4 and D9-2.

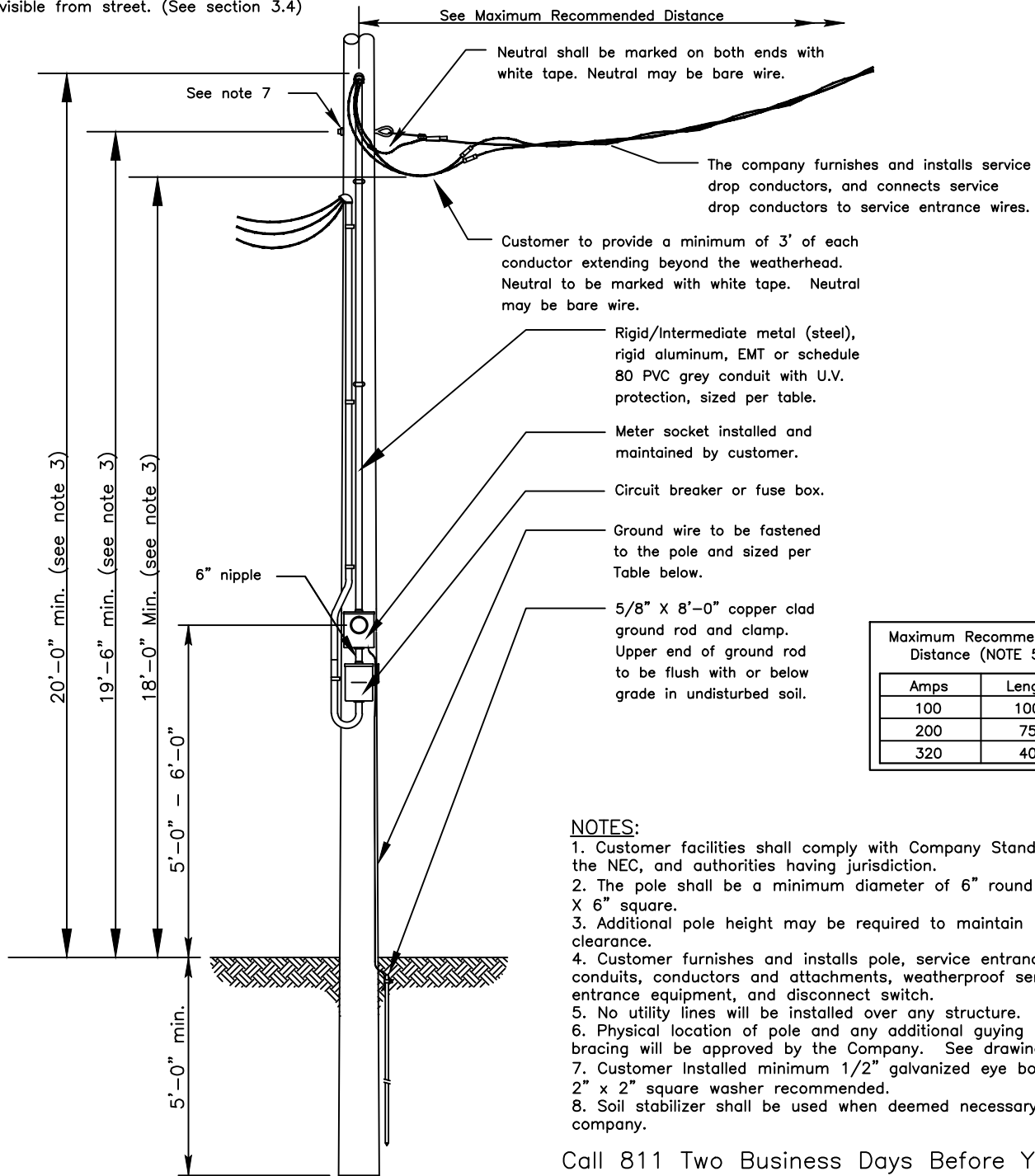

Maximum Recommended Distance (NOTE 5)	
Amps	Length
100	100'
200	75'
320	40'

**NOTES:**

1. Customer facilities shall comply with Company Standards, the NEC, and authorities having jurisdiction.
2. The pole shall be a minimum diameter of 6" round or 6" X 6" square.
3. Additional pole height may be required to maintain proper clearance.
4. Customer furnishes and installs pole, service entrance conduits, conductors and attachments, weatherproof service entrance equipment, and disconnect switch.
5. No utility lines will be installed over any structure.
6. Physical location of pole and any additional guying or bracing will be approved by the Company. See drawing D2-1.
7. Customer Installed minimum 1/2" galvanized eye bolt with 2" x 2" square washer recommended.
8. Soil stabilizer shall be used when deemed necessary by company.

Call 811 Two Business Days Before You Dig

In locations with underground facilities, the Customer shall notify One Call and shall have One Call locate all underground facilities before digging. It shall be the responsibility of the Customer to stay clear of all underground facilities.

Minimum Customer Wiring Size - Residence Single Phase **				
METER SIZE	CONDUIT SIZE	Current carrying & neutral wire size (per NEC) *		GROUND WIRE SIZE
		ALUMINUM	COPPER	
100 Amp	1.5"	#2	#4	#6 *
200 Amp	2"	4/0	2/0	#4
320 Amp	3"	500	350	#2

\* Wire sizes based upon customer breaker size  
 \*\* For 3Ø, consult the Company, Commercial & Industrial wire sizes are typically larger.

<b>ENERGY SERVICES, INC.</b>	
TYPICAL INSTALLATION - CENTRAL SERVICE POLE (FARMS & MULTIPLE SERVICE DROPS)	
APPROVED BY: JRH	DATE: 01/09/2013
CHECKED BY: JED	SCALE: NONE
DRAWN BY: krich95	
No. D4-7	
<b>Entergy</b>	
PLOT 1=1	SH. 1 OF 1

2	06/15/17	Revised notes as needed.	ERG
1	01/13	REVISION OF DRAWING SS4.8-1	JED
NO.	DATE:	REVISION	BY: APPR:

**WRONG POSITION TO SET METER POLE**

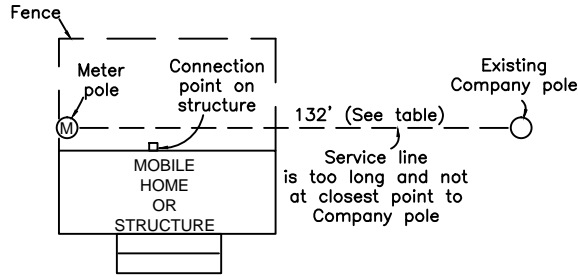

Meter point shall not be behind the mobile home on inside of fence.

**METER POLE SET CORRECTLY**

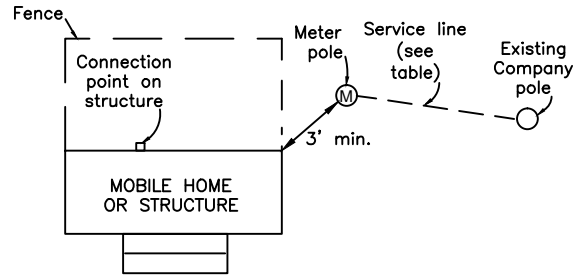

Meter point shall be outside of fence and clear of shrubs.

SERVICE CABLE IS NOT ALLOWED ABOVE OR BELOW A STRUCTURE INCLUDING CARPORT.

**WRONG POSITION TO SET METER POLE**

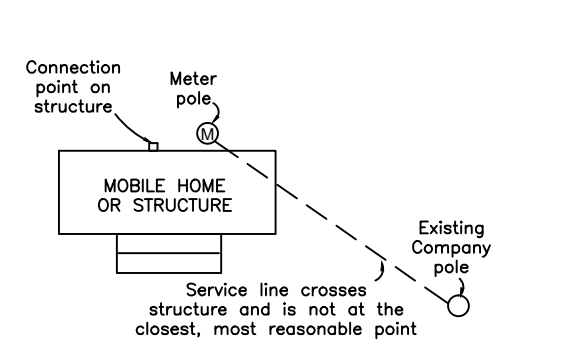

Service line crosses structure and is not at the closest, most reasonable point

**METER POLE SET CORRECTLY**

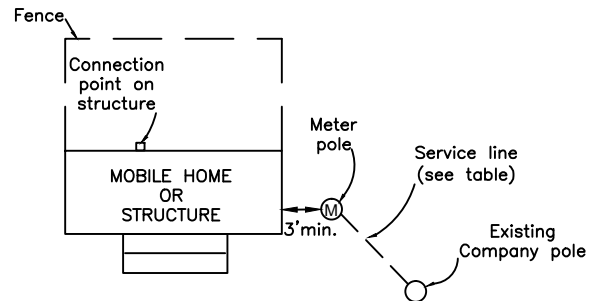

Service line does not cross over structure

**METER CLEARANCES**

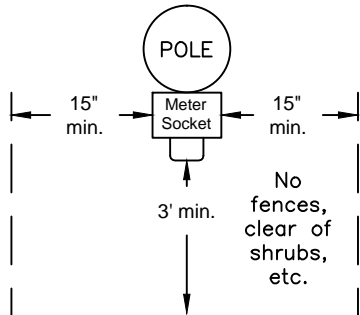

**CAUTION:**

No gas meters within a 3' radius of meter enclosure. Meter pole shall be a minimum of 3 ft. from structure.

**Maximum Recommended Distance (NOTE 3)**

Amps	Length
100	100'
200	75'
320	40'

**CALL 811 TWO BUSINESS DAYS BEFORE YOU DIG**

In locations with underground facilities, the Customer shall notify One Call and shall have One Call locate all underground facilities before digging. It shall be the responsibility of the Customer to stay clear of all underground facilities.

**Notes:**

- Customer facilities shall comply with Company Standards, the NEC, and authorities having jurisdiction.
- The customer is responsible for clearing and maintaining all right of way.
- The Company service cable shall not go over the top of the mobile home or if there is not a clear path to the meter pole or the maximum distance is exceeded, an additional pole may be required. Contact Company in advance to learn additional Customer cost. Additional Customer cost is typically \$1500 or more.

**ENTERGY SERVICES, INC.**

**PERMANENT POLE – OVERHEAD SERVICE  
DETAILS FOR SINGLE MOBILE HOME  
INSTALLATION OR STRUCTURE**

APPROVED BY: JRH	DATE: 10/30/2012
CHECKED BY: JED	SCALE: None
DRAWN BY: krich95	

2	06/15/17	Revised Meter Pole Set Correctly Details.	ERG
1	10/12	REVISION OF DRAWING SS4.6-2	JED
NO.	DATE:	REVISION	BY: APPR:

 **No. D4-4**  
PLOT 1=1 SH. 1 OF 1

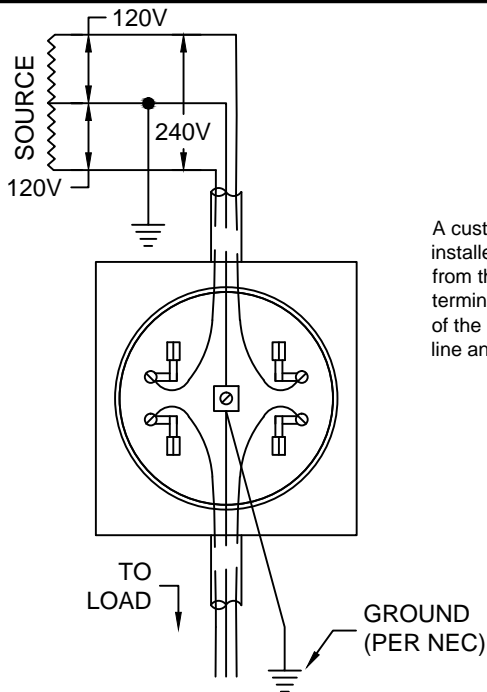

**TYPE S**  
3 WIRE SINGLE PHASE 120/240 VOLTS

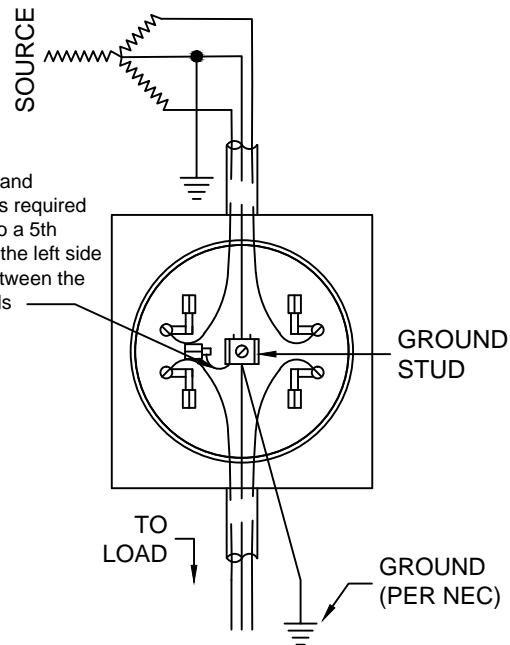

**TYPE S**  
3 WIRE SINGLE PHASE 120/208 WYE VOLTS

A customer supplied and installed teaser wire is required from the neutral lug to a 5th terminal mounted on the left side of the meter block between the line and load terminals

GROUND STUD

GROUND (PER NEC)

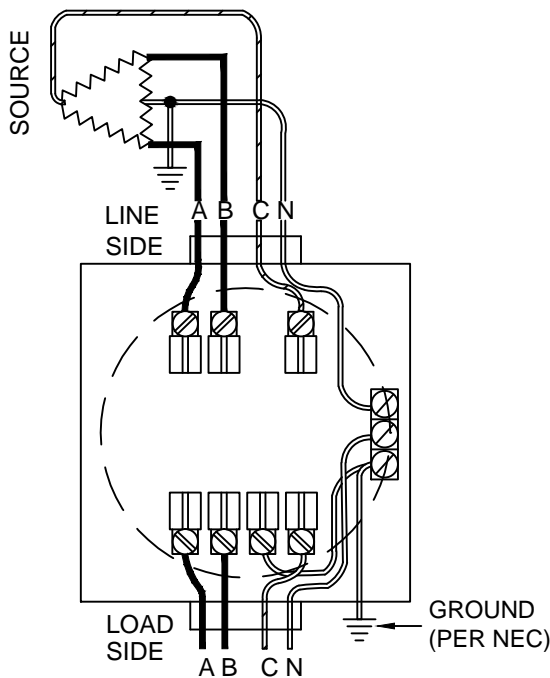

THREE PHASE 4 WIRE DELTA  
120 / 240 VOLTS

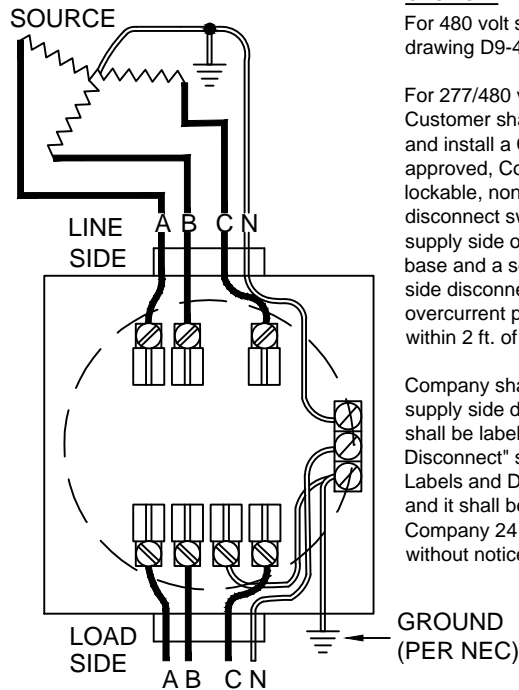

THREE PHASE 4 WIRE WYE  
120 / 208 or 277/480 VOLTS

**CAUTION:**

For 480 volt service, see drawing D9-4.

For 277/480 volt service, Customer shall furnish and install a Company approved, Company lockable, non fused disconnect switch on the supply side of the meter base and a separate load side disconnect with overcurrent protection within 2 ft. of the meter.

Company shall control the supply side disconnect. It shall be labeled "Utility Disconnect" see §1.5 Labels and Disconnects and it shall be available to Company 24 hours a day without notice.

**NOTES:**

1. Ungrounded Conductor with the Higher Voltage to Ground (Phase marked C) must be marked orange.
2. All sockets, except residential single phase less than 320 Amps, shall have a manual mechanical gang operated bypass switch.
3. Load and supply wires shall not cross in the meter socket.

2	06/15/17	Revised notes as needed.	ERG
1	01/13	REVISION OF DRAWING SS11.8-1	JED
NO.	DATE:	REVISION	BY: APPR:

ENTERGY SERVICES, INC.			
WIRING DIAGRAM CONNECTIONS FOR OVERHEAD SELF CONTAINED METERS			
APPROVED BY: JRH	DATE: 01/14/2013		
CHECKED BY: JED	SCALE: NONE		
DRAWN BY: krich95			
		No. D9-2	
		PLOT 1=1	SH. 1 OF 2

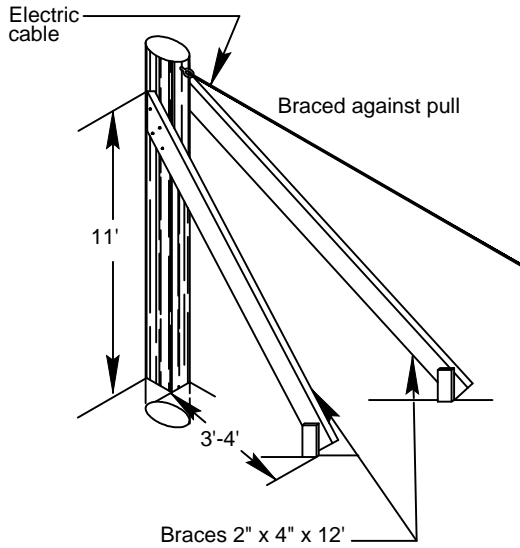

POLE

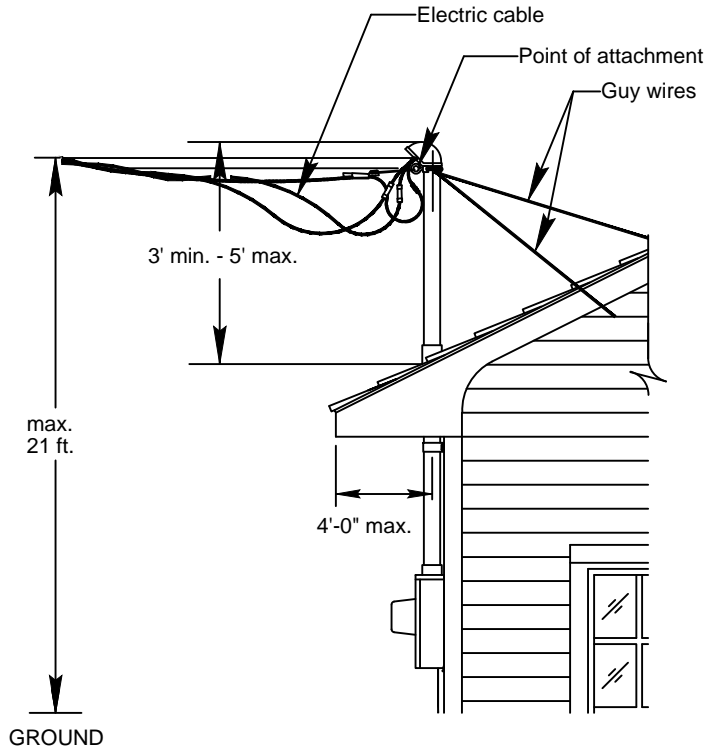

MAST ABOVE ROOF

**NOTES:**

1. Bracing is required if a pole or riser is unstable, bends, or moves when shaken or a ladder is put against it or bends when wires are attached.
2. Consult the Company for specific requirements.

CALL 811 TWO BUSINESS DAYS BEFORE YOU DIG

In locations with underground facilities, the Customer shall notify One Call and shall have One Call locate all underground facilities before digging. It shall be the responsibility of the Customer to stay clear of all underground facilities.

5				
4				
3				
2				
1	02/13	THIS DRAWING ADDED-NEW	JED	
NO.	DATE:	REVISION	BY:	APPR:

<b>ENTERGY SERVICES, INC.</b>			
<b>BRACING</b>			
APPROVED BY:	JRH	DATE:	02/26/2013
CHECKED BY:	JED	SCALE:	None
DRAWN BY:	krich95		
		No. D2-1	
PLOT	1=1	SH.	1 OF 1